



OCULAR

---

## User Guide

ENGLISH



## Accessories of Tethered Model

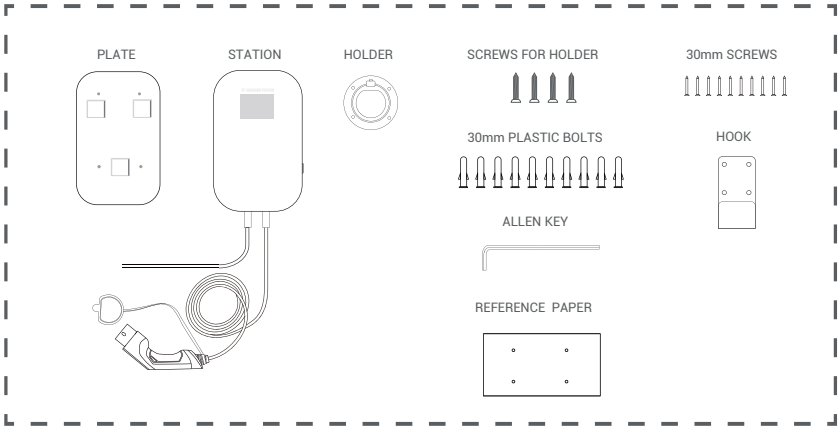

## Station Overview

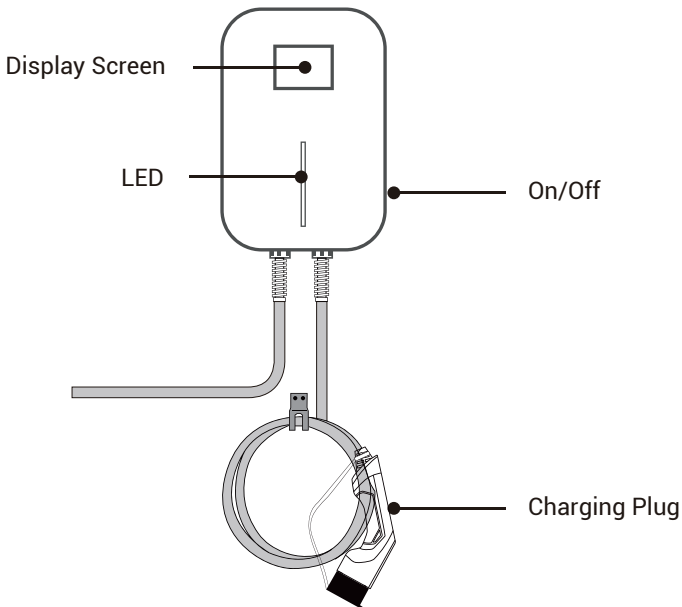

## Level 2 EV Charging Station

Phase Mode: Single Phase  
 Installation Method: Wall/Stand  
 Certificate: CE, TUV, RCM  
 IP Rating: IP66  
 Rated Voltage: 230VAC +/- 10%  
 Rated Current: 32A  
 Maximum Power: 7.4 kW  
 Ambient External Temp: -25°C ~ +55°C  
 Enclosure Material: ABS+PC alloy

Phase Mode: Three Phase  
 Installation Method: Wall/Stand  
 Certificate: CE, TUV, RCM  
 IP Rating: IP66  
 Rated Voltage: 380VAC +/- 10%  
 Rated Current: 32A  
 Maximum Power: 22 kW  
 Ambient External Temp: -25°C ~ +55°C  
 Enclosure Material: ABS+PC alloy

## Instruction for Use

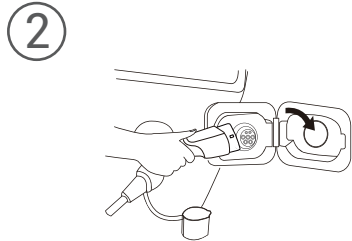
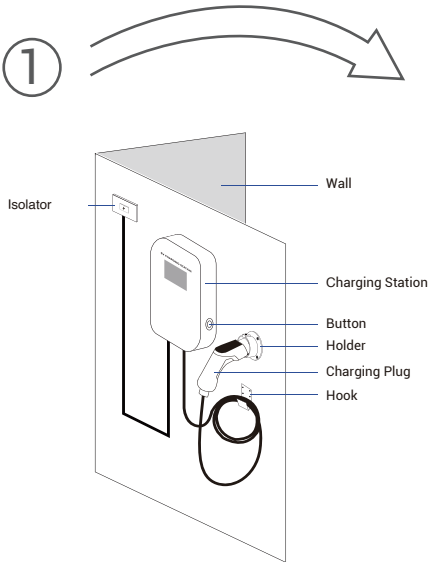

Connect the EV and the wallbox with the EV charging cable

Make sure the wallbox is connected to power

◆ Hang the cable on the hook when it is not in use

# Installation Guide

1

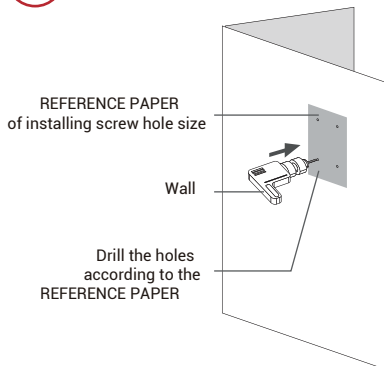

2

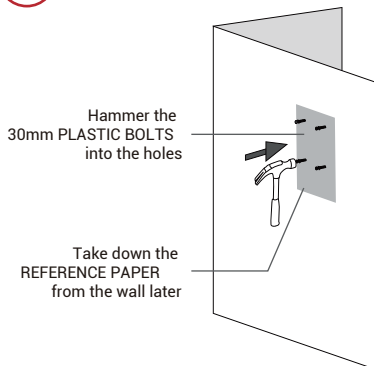

3

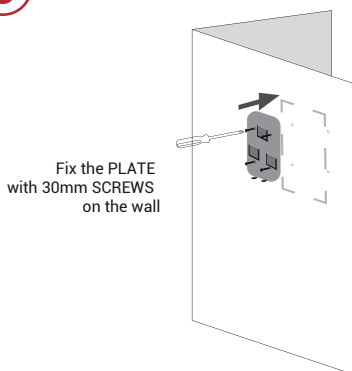

4

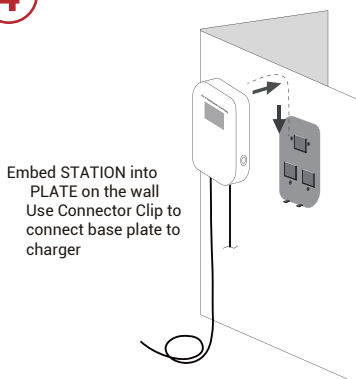

5

This is the final completion pic,  
you can put the HOOK  
and HOLDER  
anywhere you need

The cable can  
be hung on the  
HOOK and HOLDER

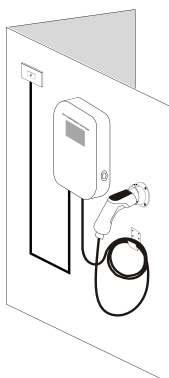

6

Tear off the protector

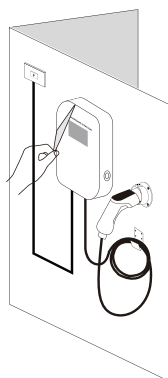

# Wallbox Overview

## Accessories of Universal Model

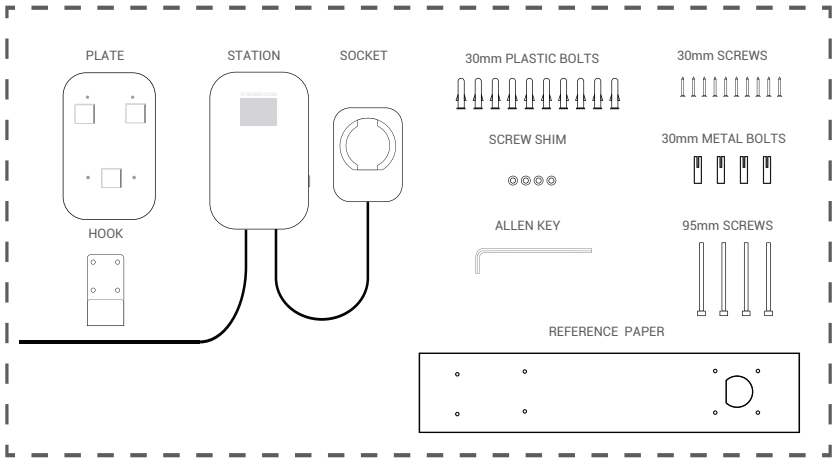

## Overview

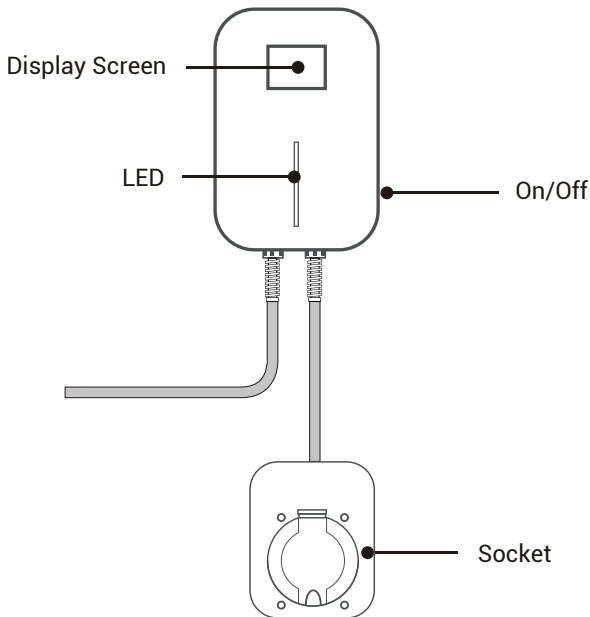

## Level 2 EV Charging Station

**Phase Mode:** Single Phase  
**Installation Method:** Wall/Stand  
**Mode:** Universal Socket  
**Certificate:** CE, TUV, RCM  
**IP Rating:** IP66  
**Rated Voltage:** 230VAC+/-10%  
**Rated Current:** 32A  
**Maximum Power:** 7.4 kW  
**Ambient External Temp:** -25°C ~ +55°C  
**Enclosure Material:** ABS+PC alloy  
**Start Mode:** Button (default)

**Phase Mode:** Three Phase  
**Installation Method:** Wall/Stand  
**Mode:** Universal Socket  
**Certificate:** CE, TUV, RCM  
**IP Rating:** IP66  
**Rated Voltage:** 380VAC+/-10%  
**Rated Current:** 32A  
**Maximum Power:** 22 kW  
**Ambient External Temp:** -25°C ~ +55°C  
**Enclosure Material:** ABS+PC alloy  
**Start Mode:** Button (default)

## Instruction for Use

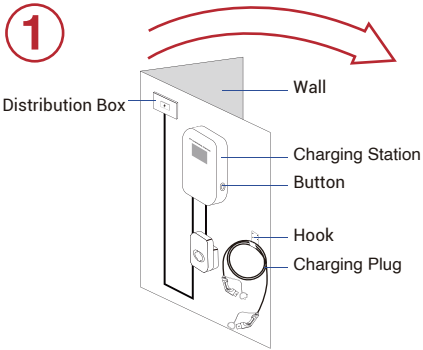

Make sure the walbox is connected to power

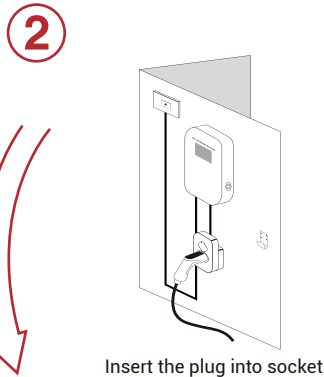

Insert the plug into socket

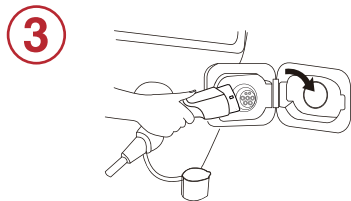

Connect the EV and the wallbox with the EV charging cable

◆ Hang the cable on the hook when it is not in use

# Installation Guide

1

REFERENCE PAPER  
of installing screw hole size

Wall

Drill the holes according to  
the REFERENCE PAPER

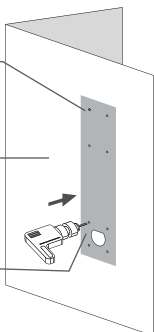

2

Hammer the  
30mm PLASTIC BOLTS  
into the holes

Hammer the  
30mm METAL BOLTS  
into the holes

Take down the  
REFERENCE PAPER  
from the wall later

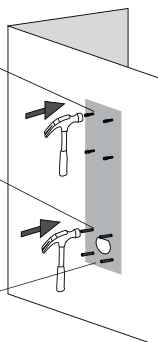

3

Fix the PLATE with  
30mm SCREWS on the wall

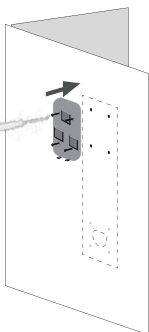

4

Embed STATION  
into PLATE on the wall  
Use Connector Clip  
to connect base plate to  
charger

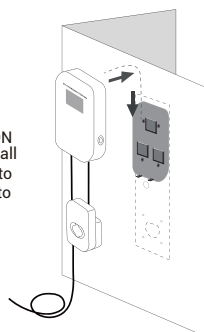

5

Take out the plate from  
the body of charging  
SOCKET

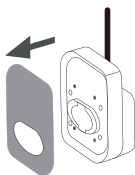

6

Fix the SOCKET on the wall  
with 95mm SCREWS  
by ALLEN KEY  
and put the plate back to the  
body of SOCKET

95mm SCREWS

Screw Shim

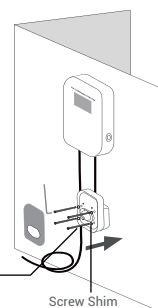

7

Connect the inlet cable and  
the power supply correctly

This is the final completion pic,  
you can put the HOOK  
anywhere you need

The cable can be hung on the  
HOOK

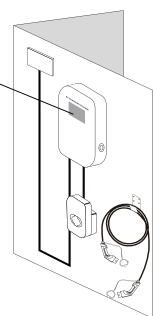

8

Tear off the protector

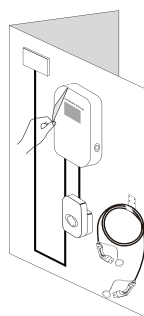



## Illustration of Screen and LED

### SINGLE PHASE

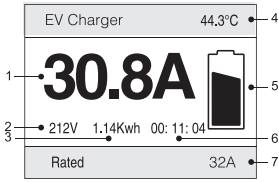

1. Real-time current
2. Real-time voltage
3. Power consumed
4. Temperature
5. Charging icon
6. Charging time
7. Rated current

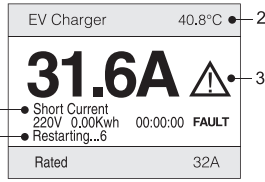

1. Cause of fault
2. Temperature
3. Fault icon
4. Automatic restart

### THREE PHASE

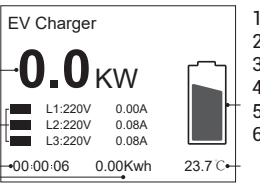
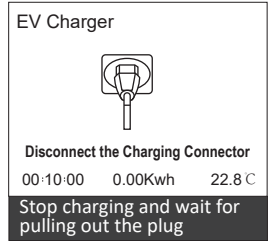
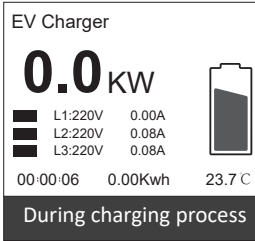
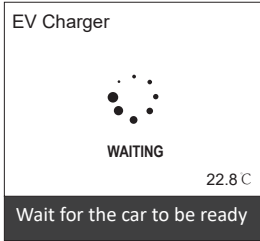
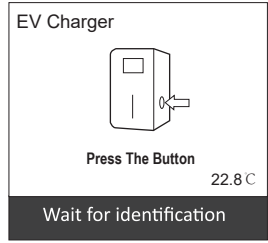
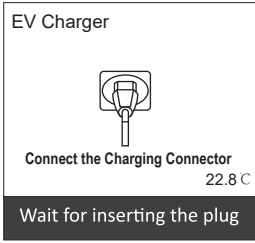
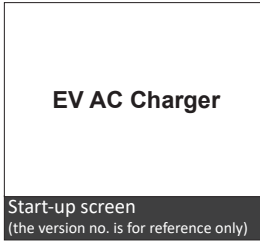

1. Real-time power
2. Three Live Wire data
3. Charging Time
4. Power Consumption
5. Charging Icon
6. PCB Temperature

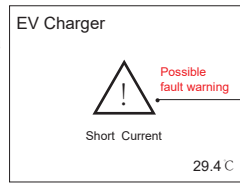

1. Emergency stop
2. Over Current
3. Over Temperature
4. Leakage protection
5. Short Current

	IDLE	CONNECTED	CHARGING	FINISHED	ERROR
Instruction of LED Status	OFF	Continuous light	Rolling	Continuous light	Red flashing

**Note:** The Ocular LTE will automatically restart when minor problems occur.

For serious failures, the system cannot automatically recover. In order to remind user of this failure, the system will automatically countdown 10 seconds to restart.

## Safety Warning

Failure to follow instructions may result in danger!

- ▲ Regularly check whether the charging station has visible damage.
- ▲ Make sure that all safety facilities are available at all times and are tested regularly to ensure they can operate normally. Visit [ocularcharging.com.au](http://ocularcharging.com.au) for a yearly maintenance check according to Australian standards.
- ▲ If a ground fault occurs, it must be assumed that the cable carries voltage. Please confirm that there's no high-voltage power in the system before inspecting the charging station.
- ▲ Persons who install and use charging stations must obey the principles and regulations mentioned to ensure personal and equipment safety.
- ▲ Before powering on the device, please confirm that the device is properly grounded to avoid unnecessary accidents.
- ▲ All tools' unnecessarily exposed metal parts should be insulated to prevent them from touching the metal frame to avoid short circuits.
- ▲ Do not modify, retrofit, or change any part by yourself under any circumstances.
- ▲ To ensure the service life and stable operation of the charging station, the operating environment should be kept clean as possible with a relatively stable temperature and humidity. The charging station must not be used in a flammable environment or environments with volatile gas.
- ▲ Be sure to confirm that the input voltage, frequency, circuit breakers and other conditions of the device meet the specifications before the device is powered on

## Maintenance

Ocular LTE is only recommended for use in residential applications and use outside of this area (i.e. for commercial application) is outside of warranty.

In order to ensure the normal service life of the charging station and reduce risk, maintenance must be performed every 12 months. The maintenance and installation of the equipment must be completed by licensed electricians with. Visit [ocularcharging.com.au](http://ocularcharging.com.au) to book your service.

The product should be placed at an ambient temperature of  $-25^{\circ}\text{C}\sim+55^{\circ}\text{C}$  in relative humidity of no more than 95%. The air should not contain acids, alkalis, or other corrosive and explosive gases.

Ocular Charging Stations are subject to stringent quality inspections. From the day of purchase, any problem quality can be reflected to the dealer within two years.

Any direct damage or malfunction caused by neglect, incorrect use, installation, usage, repair by the users or natural damage are not covered by the warranty.

MANUFACTURER  
Ocular Charging

[ocularcharging.com.au](http://ocularcharging.com.au)  
[sales@ocularcharging.com.au](mailto:sales@ocularcharging.com.au)





MANUFACTURER  
Ocular Charging

[ocularcharging.com.au](http://ocularcharging.com.au)  
[sales@ocularcharging.com.au](mailto:sales@ocularcharging.com.au)